

# ACRYLIC SHIELD PANEL HOLDERS - SPEC SHEET

**Adhesive Panel Holders**, designed for use with custom interlocking acrylic shields, **maintain alignment and add stability** to your gapless acrylic configuration. Available in three standard options or customizable to meet your needs.

## Straight Adhesive Panel Holder

XPSHSC

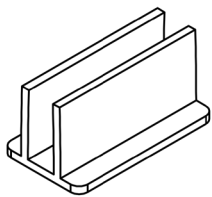

TOP VIEW

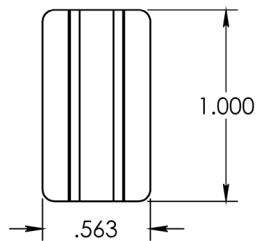

END VIEW

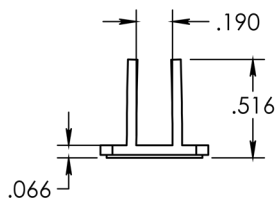

## X Adhesive Panel Holder

XPSHXC

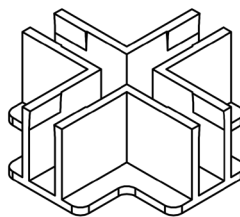

TOP VIEW

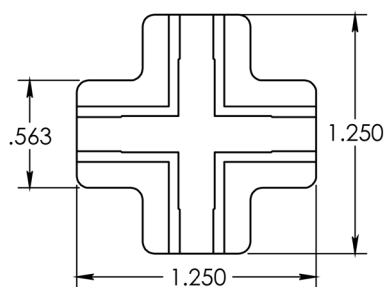

END VIEW

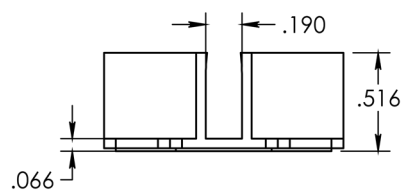

## Y Adhesive Panel Holder

XPSHYC

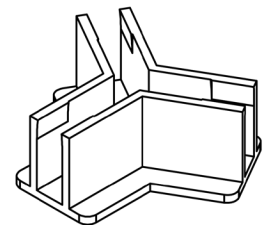

TOP VIEW

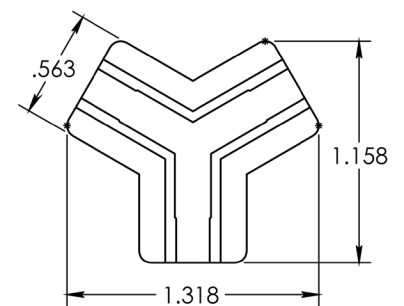

END VIEW

